

EDH2

Electromagnetic Door Holder Wall Mounted - 1-7/8" to 2-7/8" Projection

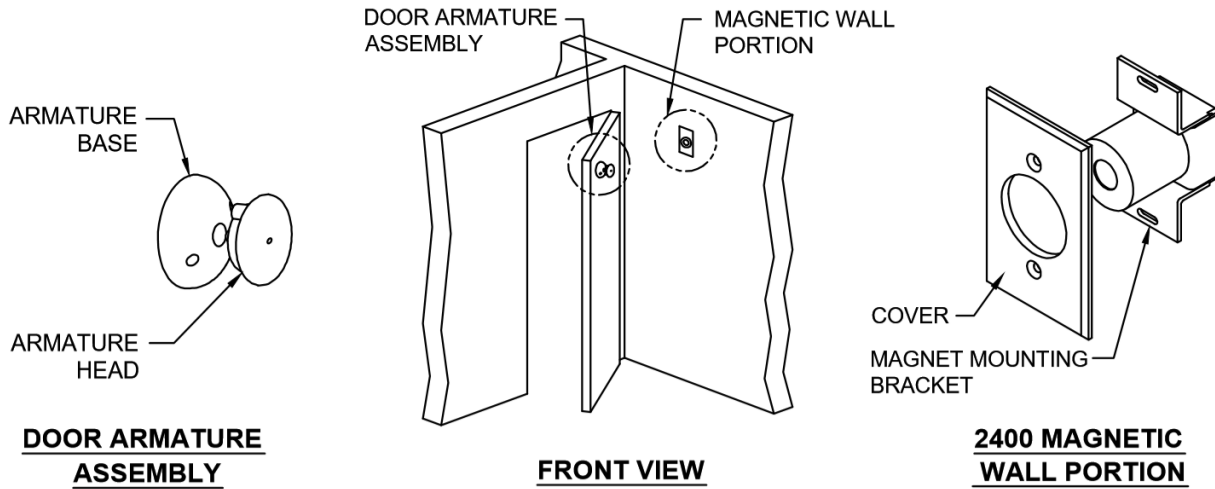

Electrical Data:

THIS PRODUCT IS AN ELECTROMAGNETIC HOLDING DEVICE, INTENDED FOR USE IN FIRE DOOR APPLICATIONS, BUT CAN BE USED FOR OTHER MAGNETIC APPLICATIONS. WIRE INTO PROPER TERMINALS AS NOTED BELOW:

SERIES	VOLTAGE	DC/mA	DC/VA	AC/mA	AC/VA	TERMINALS
EDH3	12 DC	60	.72			Com & 12 v
	24 AC/DC	30	.72	30	.72	Com & 24 v
	120 AC			30	3.60	Com & 120 v

Electrical Configuration:

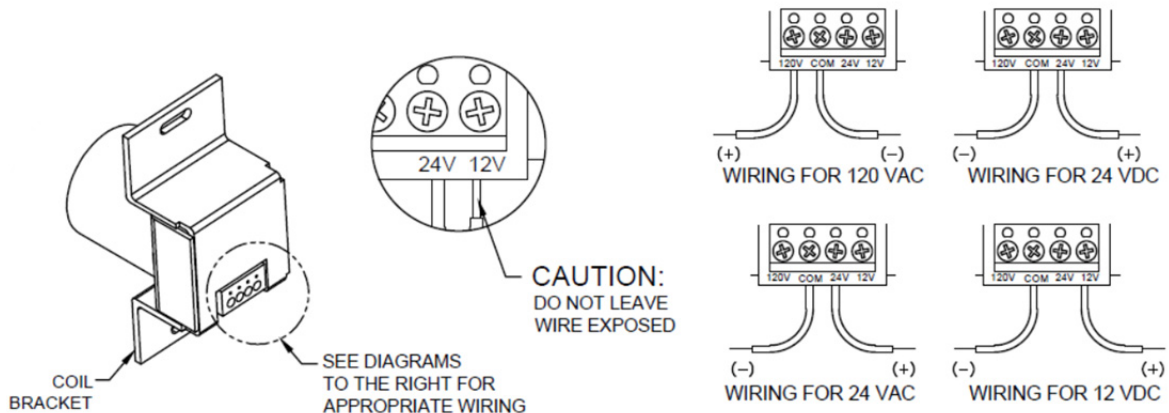

SCREW DETAIL		
	QTY	SCREW
MAGNETIC WALL PORTION	2	6-32 x 1" OVAL HEAD MACHINE SCREW
DOOR ARMATURE	2	10-32 x 1" PAN HEAD MACHINE SCREW

Mounting Position:

The magnet/armature should be located 3-1/2" down from the top of the door and 5" in from the door edge. Coordinate with other hardware items such as door closers to ensure no interferences exist. The standard package includes a 1" extension to cover 1-7/8" and 2-7/8" pockets behind the door at 90°. Contact the factory if additional extensions are needed.

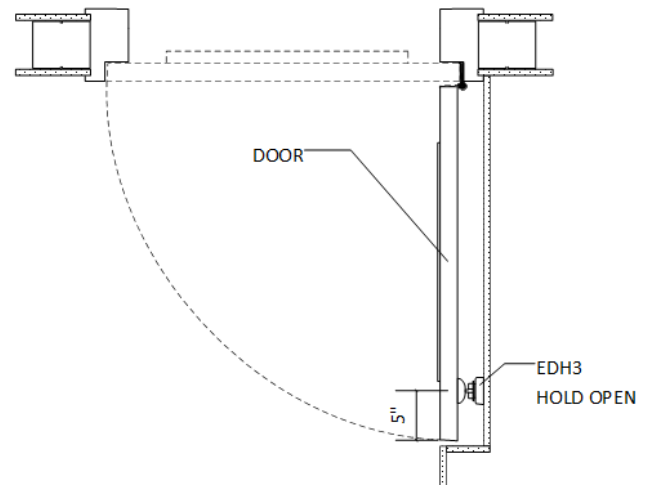
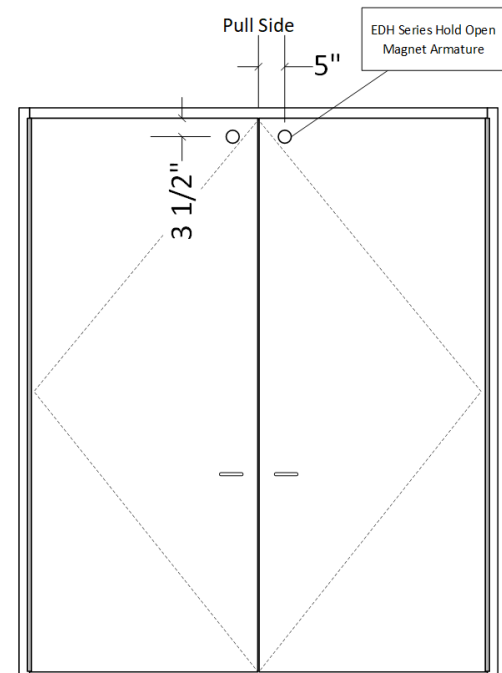

Door Armature Installation:

Due to special reinforcing within Syntégra doors, thru-bolts are not required to attach the armature!

1. Place and center the door armature on the surface of the magnet with the two holes of the base aligned horizontally.
2. Gently close the door and adjust the angle of the door armature so the base lays flat against the door.
3. While keeping slight pressure on the door, mark location of door armature through the two base holes.
4. Drill and tap (#10-32) through the door face only where the two marks are located.
5. Fasten with the (2) #10-32 machine screws.

